

# WHERE MAGIC HAPPENS...



# WHY CHOOSE OUTDOOR?

---

## **Top quality and durability**

Renson® is the European trendsetter in the field of natural ventilation, outdoor sun protection and outdoor products. We manufacture our high quality products ourselves in our state-of-the-art production facilities. We test our products in the most extreme conditions until we achieve a flawless end result.

This allows us to guarantee our customers optimal quality. Our network of well-trained Ambassadors guarantees a flawless service, placement and after-sales service. Professionalism from start to finish.

## **Minimalist design**

Our products are highly innovative in both look and product design. Seamless integration of optional elements, concealed mounting parts, durable materials and smart solutions ensure a perfectly finished product that can be integrated with any type of home.

## **Endless personalization possibilities**

Due to our modular product design and countless integrable options, we can offer you a perfectly tailored solution. Personalize bare screens, large colour selection, sliding panels in various designs, glass walls, heating, music,.... these are just a few of the different options that lead to a unique personal solution.

## **Ultimate ease of use and maintenance**

Our products must retain their qualities for many years, day in and day out, in all weather conditions and must be used quickly.

That is why the products are also made from the most qualitative and durable materials and you will enjoy them for many years, subject to a minimum of maintenance.



# SQUARE DESIGN



**LOUVERED ROOFS**  
(rotatable louvered roof)

## CAMARGUE® LINE

**CAMARGUE®**



This innovative and modular mountable patio cover can be supplemented with perfectly integrated side elements.

---

**LOUVERED ROOFS**  
(rotatable and retractable louvered roof)

**CAMARGUE SKYE®**



A fully closable patio cover with rotatable and retractable aluminium blades. Here too, side elements can be perfectly invisibly integrated.

---

**FIXED ROOF**

## ALGARVE® LINE

### ALGARVE®



A horizontal sun and water resistant roof with tiltable aluminium blades. Side elements are possible in surface mounted.

## AERO® LINE

### AERO®



Horizontal sun and water resistant roof with tiltable aluminium blades, perfectly integrable into new or existing structures.

### AERO SKYE®



1. AERO SKYE®
2. AERO SKYE® Dual



Aero Skye with rotating and retractable blades to create a panoramic view. With Aero Skye Dual, the blades slide open from the centre without interfering transverse profile for spans up to 11.75 m.

### ALGARVE CANVAS®



Covering with fixed roof, aesthetically finished with fixed ceiling with Fixscreen-technology.

# INCLINED DESIGN



LAGUNE®

## RETRACTABLE FIXSCREEN ROOF

## LAGUNE®



This patio cover has a sun-, water- and windproof translucent fabric in the roof structure. Side elements can be seamlessly integrated.

---

## RETRACTABLE VELUM CANVAS ROOF

## LAPURE®

### LAPURE®



Minimalist patio cover with water, wind and sun resistant screen roof and open panoramic view. Side elements are possible in surface mounted.

## TOSCANE®

### TOSCANE®



The innovation for larger surface areas: the folding roof provides protection from water, wind and sun. Side elements can be perfectly integrated.







# CAMARGUE® LINE

## CAMARGUE® & CAMARGUE SKYE®

---

### Characteristics

- Camargue® 10
- Camargue Skye® 11
- Construction options 12
- Range 14

### Accessories

- Lighting 56
- Heating and music 59
- Translucent blades - Lineo® Luce 60

### Side fills

- Side elements 62
- Outdoor curtains 63
- Glass sliding panel 64
- Loggia® sliding panels 66
- Linius Wall 68
- Loggia® quick passage / sliding door 70
- Integrated Fixscreen® 71
- Fibreglass fabrics Fixscreen® 73
- Crystal windows 74

# CAMARGUE®

---

## Fully integrated design solution

The roof consists of extruded aluminium blades. These blades can rotate to control sun protection and ventilation according to needs. Control is easy with a Somfy handheld transmitter. When closed, the roof is water resistant. Water is discharged to the columns via integrated water guiding ducts. This water drainage also works when opening the blades after a rain shower, so that the furniture on the terrace remains protected.



*Efficiently integrated water drainage*



*Controlled water drainage also for opening rotating blades*



*A patio cover can be easily operated with Somfy automation*

# CAMARGUE SKYE®

## Patio cover with retractable louvered roof

This most exclusive model in the Renson® range of patio covers is equipped with aluminium blades in the roof which can be rotated and opened. The blades provide protection against rain, sun and wind. In summer, hot air can escape and in winter, the roof can be slid open to fully enjoy the sunlight. This is particularly important when the Camargue Skye is placed against a façade, so you are still able to enjoy entering sunlight indoors.

The blades of a Camargue Skye patio cover are designed in a way that they extract precipitation laterally.

All fixings, wiring and anchorages are invisibly removed and the patio cover can be fitted with LED lighting in the columns or frame, multifunctional design beam with thermal comfort and speakers. Camargue Skye can be assembled in different ways: stand-alone, fastened

against an external façade, built-in or integrated between 2 walls. Windproof screens, sliding panels in glass, aluminium or wood, a fixed wall and outdoor curtains can also be integrated.



- Orientable roof blades for discharging hot air and for protection against sun, rain or wind
- Retractable roof blades for maximum light intensity and a wide, open view
- The roof is perfectly flat in closed position
- Double-walled blades for higher snow loads and acoustic and thermal insulation
- Synchronous drive on both sides of the blades: the roof also opens and closes smoothly, even when there are asymmetric loads
- There is no play between the blades



# CONSTRUCTION OPTIONS

---

## Building types

There are 2 possible building types to install the Camargue Line: stand-alone and façade mounting.



*Stand-alone: the Camargue Line frame is supported by 4 vertical columns*



*Façade mounting: the frame is placed with one or two sides against a supporting structure or structure behind it. Vertical columns support the other part. The blades can be placed parallel or perpendicular to the structure behind.*

## Joinable

Camargue Line can be coupled for covering larger areas in order to obtain a

larger Span or Pivot. A coupling beam is used for this purpose.



*2 sections joinable on Pivot side*



*Camargue Skye 2 sections joinable on Span side, equal sliding direction and orientation*



*2 sections joinable on Span side*



*Camargue Skye 2 sections joinable on Span side, opposite sliding direction and orientation*

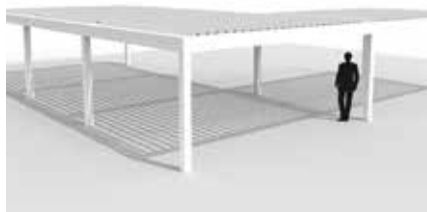

*Multiple parts joinable on pivot and/or Span side*



*Camargue Skye 2 sections joinable on Pivot side*

### Integrated Fixscreen®

By integrating the vertical sun protection, the integrated Fixscreen, whether or not equipped with Crystal windows to maximize the view outwards, you can create an additional outdoor area where you are protected from sun, rain and wind. These screens are available in 50 colours and allow you to **personalize** the Camargue Line and create the atmosphere you want.



The Camargue Line is equipped with integrated Fixscreen on the Span and Pivot side

### Personalization possibilities

The Camargue Line can be fitted with various elements on the front and/or sides. By adding side elements, endless customisation possibilities are generated.



Loggia sliding panel: Loggiawood, Loggiawood privacy, Loggiascreen Canvas, Loggialu, Loggialu Privacy



Glass sliding panel + integrated Fixscreen



Quick passage Loggia: Loggiascreen Canvas



Linius fixed wall: full passage height or height as desired



Glass sliding panel

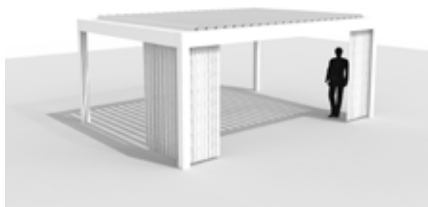

Curtains

### Mounting feet

There are 3 types of mounting feet: a visible, an invisible and an invisible cast mounting base.

Furthermore, a reinforced mounting base is available in both visible and invisible versions when side fills are used or on locations with increased wind forces.

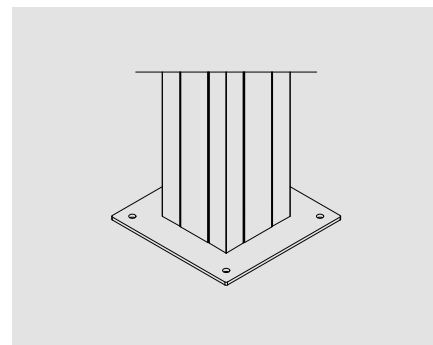

Visible mounting base

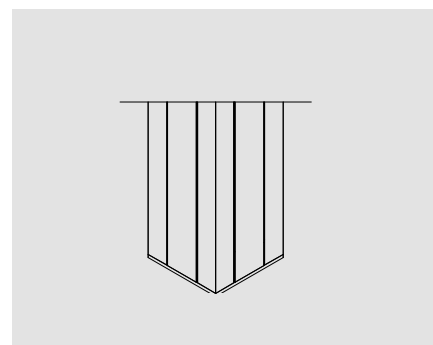

Invisible mounting base

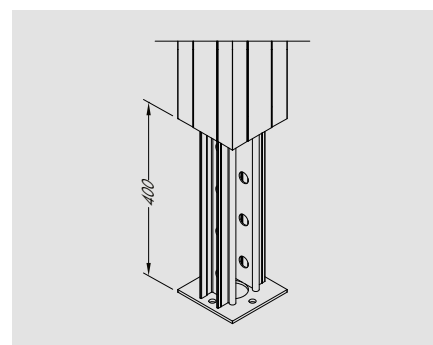

Cast mounting base

		SQUARE DESIGN	
		CAMARGUE® LINE	
TYPE		Camargue®	Camargue Skye®
			
<b>ROOF FILL</b>		Rotating blades	Rotating and retractable blades
<b>DIMENSIONS</b>			
	Max. width / pivot	6200 mm	
	Max. depth / span	4500 mm	
	Max. passage height	2800 mm	
	Joinable	multiple parts joinable	
	Min. slope	no slope (0°)	
	Max. blade rotation	150°	145°
<b>ACCESSORIES</b>			
<b>SIDE PROFILES</b>	Integrated Fixscreen	optional	optional
	Fixscreen surface mounted	-	-
	Loggia sliding panels	optional	optional
	Quick passage Loggiascreen Canvas	optional	optional
	Glass walls	optional	optional
	Linius wall passage height	optional	optional
	Linius wall as railing	optional	optional
	Triangle	-	-
	Outdoor curtains	optional	optional
	Additional column	optional	optional
	Shifted column	optional	optional
	Adjustable wall profile	optional	optional
<b>LIGHTING</b>	Lineo LED	optional	-
	UpDown LED	optional	optional
	Colomno LED	optional	optional
	Lapure LED	-	-
	Lagune LED	-	-
	Toscane LED	-	-
<b>COMFORT &amp; DESIGN</b>	Beam Heat & Sound	optional	optional
	Translucent blades Lineo Luce	optional	-
	Wooddesign	optional	optional

You can find all the information about the options and technical specifications in our technical catalogue that you can find in the showroom of your local Renson dealer. For all distribution points, see [www.renson-outdoor.com](http://www.renson-outdoor.com)

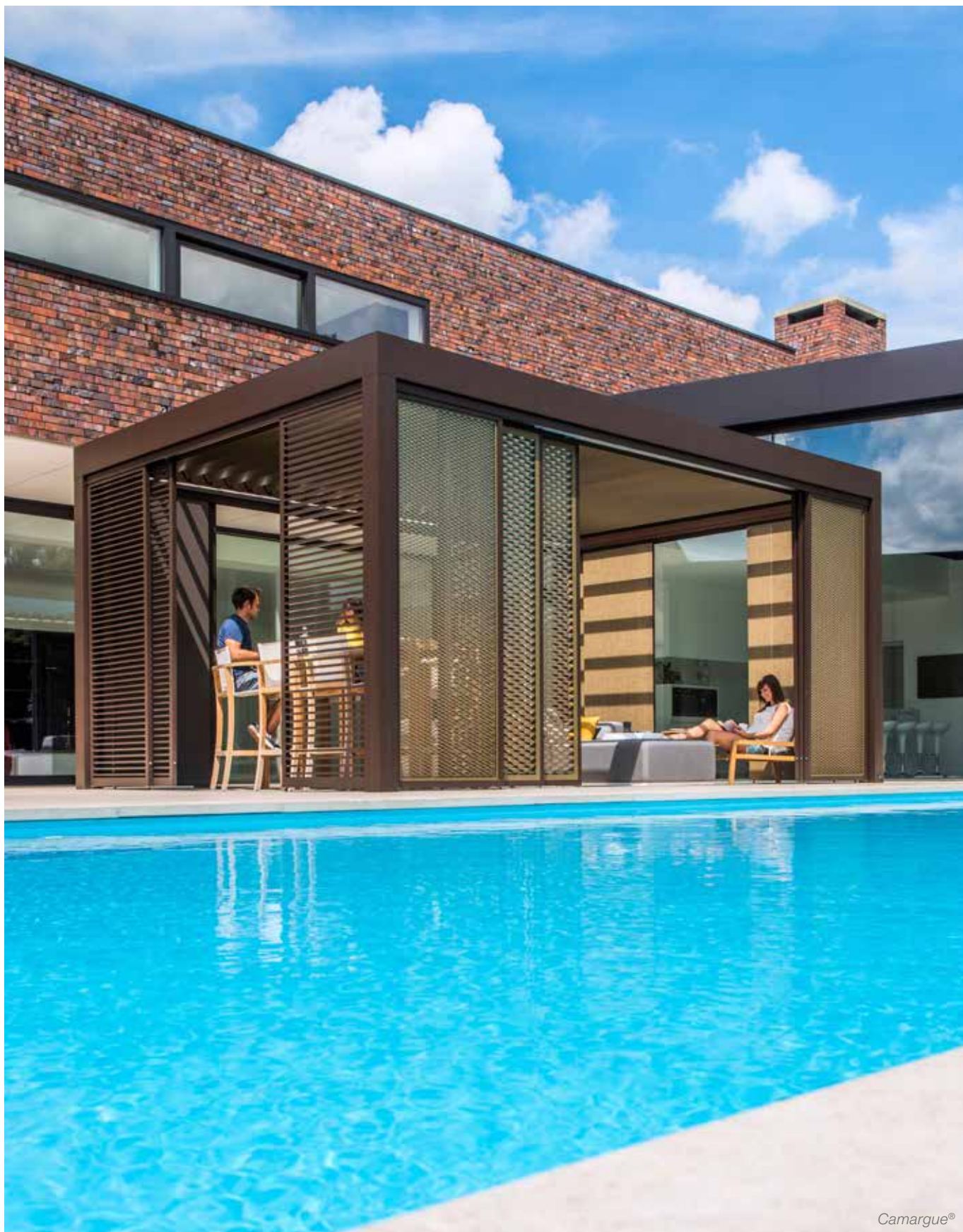

Camargue®







# ALGARVE® LINE

## ALGARVE® & ALGARVE CANVAS®

---

### Characteristics

- Algarve® 18
- Algarve Canvas® 19
- Algarve® 'Classic Line' 20
- Construction options 22
- Range 24

### Accessories

- Lighting 56
- Heating and music 59
- Translucent blades - Lineo® Luce 60

### Side fills

- Side elements 62
- Outdoor curtains 63
- Glass sliding panel 64
- Loggia® sliding panels 66
- Linius Wall 68
- Surface mounted fixscreen® 72
- Fibreglass fabrics Fixscreen® 73
- Crystal windows 74

# ALGARVE®

---

## Horizontal sun protection roof with rotatable blades

This simple and practical patio cover provides a sun protection roof with rotatable blades. The aluminium extruded blades can be rotated up to 150° and therefore offer you the possibility to determine in which way you want your sun protection and/or ventilation.

When closed, the blades form a waterproof roof. The rainwater is led to the columns through a gutter. Due to its elegant, lightweight design and availability in all RAL colours, the Algarve fits every architectural style: contemporary, classic or modern. Moreover, all screws are hidden.

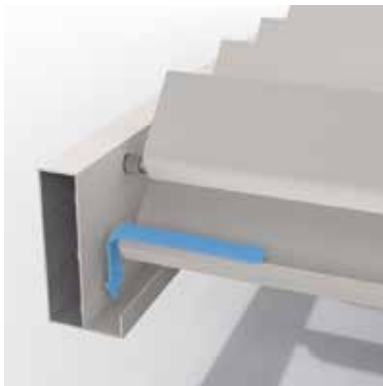

Gutter

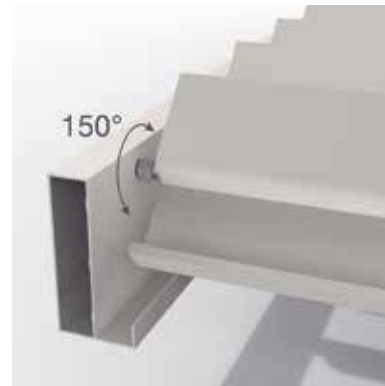

150° rotatable

# ALGARVE CANVAS®

---

This elegant covering provides permanent protection by means of a fixed roof, built up from 2 layers: a solid top roof from white painted profiled steel sheet with anti-condensation coating and an aesthetic bottom roof, finished with stretched fabric with zipper technology. The fabric is stretched tight in the structure, without visible intermediate beams and is available in 8 colours. Algarve Canvas is even useful as a fixed patio cover, carport or an awning above the front door. Moreover, a combination is possible of an Algarve with rotating louvered roof and an Algarve Canvas with fixed roof structure, to create 1 uniform style around the house.



*Roof section*



*Water drainage*



Algarve® 'Classic Line'

**Algarve® 'Classic Line'****Durable patio cover with beautiful classic look and feel**

**Algarve 'Classic Line'** is a new line in the range of patio covers with tilttable aluminium blades in the roof that allow you to determine the incidence of light on the terrace completely yourself and protect you from rain. The classic finishing with decorative frames and decorative lines in the columns make **Algarve's 'Classic Line'** a durable and maintenance friendly solution with a beautiful classic look. This patio cover can be mounted on the façade or can be stand-alone, the ideal solution for a rural or classic architectural style.



# CONSTRUCTION OPTIONS

## Building types



*Algarve - Stand-alone*



*Algarve Canvas - Stand-alone*



*Algarve - Façade mounting*

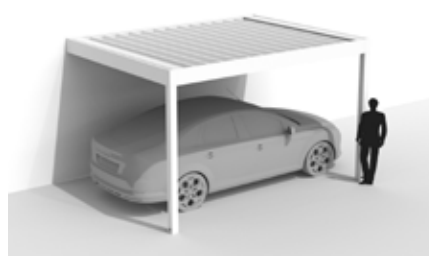

*Algarve Canvas - Façade mounting*

## Fixscreen® 100<sup>EVO</sup> Slim F / Fixscreen® 150<sup>EVO</sup> F - Algarve® Line

In order to lock off the sides of the Algarve Line, it is possible to combine them with the Fixscreen 100<sup>EVO</sup> Slim F and the Fixscreen 150<sup>EVO</sup> F. The sun protection fabric's box can be mounted under the frame profile to perfectly match the base structure.



## Joinable

The Algarve Line is 2 sections joinable (on the Span side) so that it is possible to cover exceptional surface areas of 6 x 6.05 m without visually disturbing centre columns.

Moreover, in the joined version, the Algarve Line is perfectly possible with a louvered roof in one roof part and a fixed roof in the other roof section.



*Algarve - 2 sections joinable on Span side*

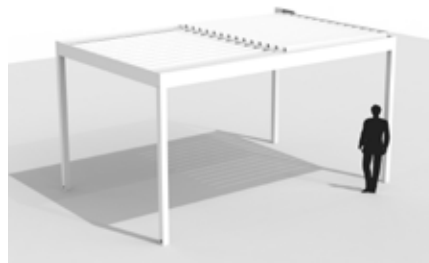

*Algarve joinable with Algarve Canvas*

### Personalization possibilities

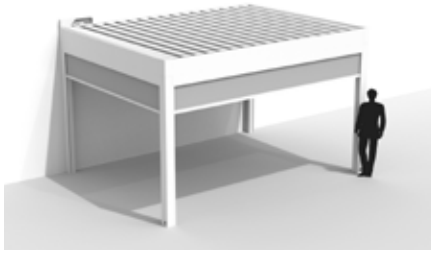

Fixscreen surface mounted

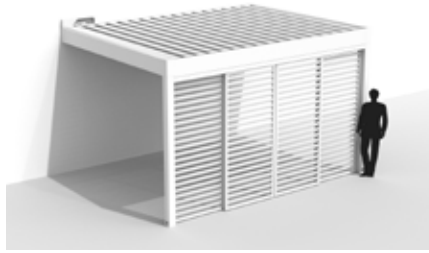

Loggia

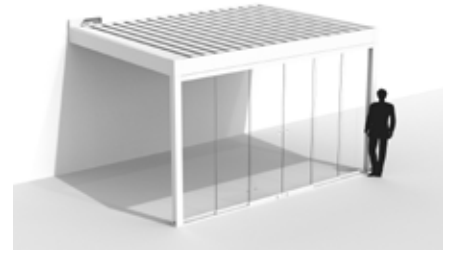

Glass sliding panel

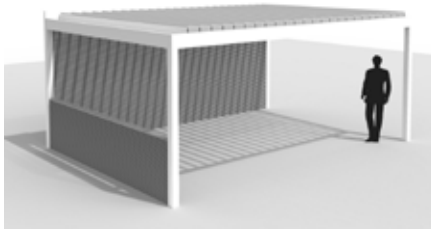

Linius fixed wall

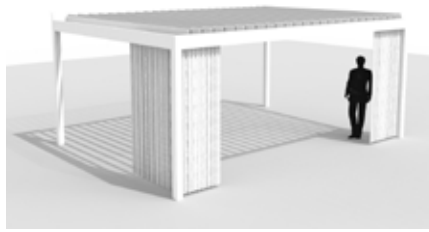

Curtains



Algarve Canvas®

		SQUARE DESIGN	
		ALGARVE® LINE	
TYPE		Algarve®	Algarve Canvas®
			
ROOF FILL		Rotating blades	Fixed roof
DIMENSIONS			
Max. width / pivot		6055 mm	
Max. depth / span		4500 / 6000 mm*	
Max. passage height		2800 mm	
Joinable		2 sections joinable	
Min. slope		no slope (0°)	
Max. blade rotation		150°	-
ACCESSORIES			
SIDE PROFILES	Integrated Fixscreen	-	-
	Fixscreen surface mounted	optional	optional
	Loggia sliding panels	optional	optional
	Quick passage Loggiascreen Canvas	-	-
	Glass walls	optional	optional
	Linus wall passage height	optional	optional
	Linus wall as railing	optional	optional
	Triangle	-	-
	Outdoor curtains	optional	optional
	Additional column	optional	optional
	Shifted column	optional	optional
Adjustable wall profile	-	-	
LIGHTING	Lineo LED	optional	-
	UpDown LED	optional	optional
	Colomno LED	-	-
	Lapure LED	-	-
	Lagune LED	-	-
	Toscane LED	-	-
COMFORT & DESIGN	Beam Heat & Sound	optional	-
	Translucent blades Lineo Luce	optional	-
	Wooddesign	optional	-

\* > 4500 mm is linked up to max. 6000 mm

You can find all the information about the options and technical specifications in our technical catalogue that you can find in the showroom of your local Renson dealer. For all distribution points, see [www.renson-outdoor.com](http://www.renson-outdoor.com)





Algarve®





# AERO® LINE

## AERO® & AERO SKYE®

---

### Characteristics

- Aero® 28
- Aero Skye® 29
- Construction options 31
- Range 32

### Accessories

- Lighting 56
- Heating and music 59
- Translucent blades - Lineo® Luce 60

### Side fills

- Side elements 62

# AERO®

---

## Innovative and modular patio cover with horizontal sun protection roof with rotating blades

**Horizontal sun and water resistant roof with tiltable blades, integrable into existing structures.**

This simple roof structure offers a sun protection roof with rotatable blades without columns.

The aluminium extruded blades can be rotated up to 150° and therefore offer you the possibility to determine in which way you want your sun protection and/or ventilation.

When closed, the blades form a waterproof roof. The rainwater is led to the corners through a gutter. Due to its elegant, lightweight design and availability in all RAL colours, the Aero fits every architectural style: contemporary, classic or modern.

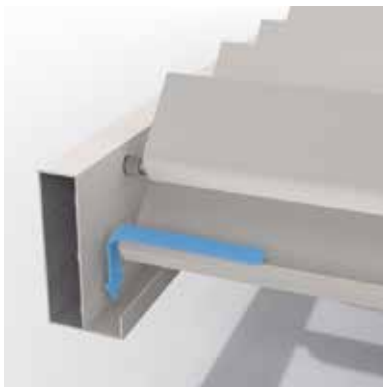

Gutter



150° rotatable

# AERO SKYE®

---

This newest and most exclusive member in the Renson® range of patio covers is a completely integrable roof structure, equipped with aluminium blades that can rotate and slide open. The blades provide protection against rain, sun and wind.

More than just a patio cover, the Aero Skye blends seamlessly into the architecture. The terrace becomes an additional outdoor room that can be used all year round.

In summer, hot air can escape if the blades are slightly rotated, but still maintaining their sun protective function.

Both in winter and summer, the roof can be slid open almost completely, to fully enjoy the sunlight.

Especially when the Aero Skye is used against a façade, this is important to still be able to enjoy the entering sunlight in the house if desired. The blades of the Skye patio cover have been designed in a way that they discharge precipitation laterally.

**Aero Skye will be available in 2 versions:**

- **Aero Skye**, where the blades slide open in one direction (to be determined at your choice in advance)
  - **Aero Skye Dual**, where the blades slide open in 2 directions. The maximal installation length here is no less than 11.75 metres, with a clear opening of more than 9 metres. The maximum width is 4.5 metres.
- All fixings, wiring and anchorages are invisibly hidden and the patio cover can be equipped with up-down LED lighting.

Aero Skye products are available from October 2018.
---



# CONSTRUCTION OPTIONS

## Building types



*Aero - Integration*

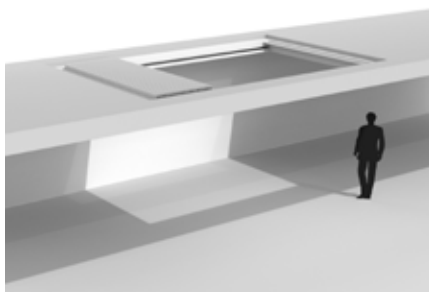

*Aero Skye - Integration*

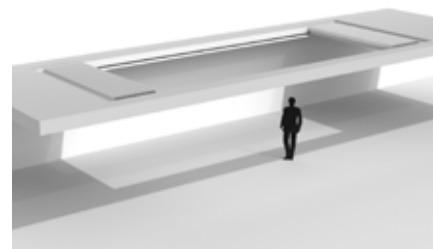

*Aero Skye Dual - Integration*



*Aero - Construction*

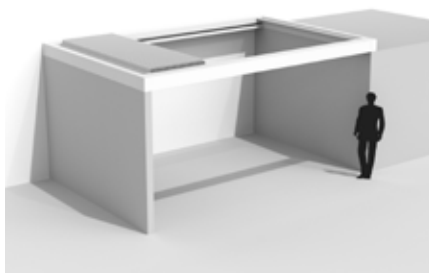

*Aero Skye - Construction*

## Joinable

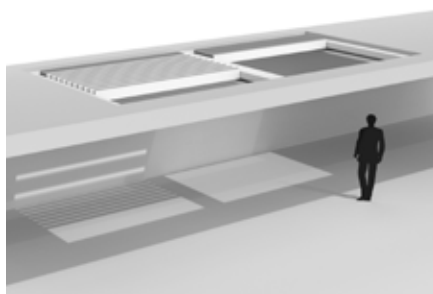

*Aero Skye - joinable integration*

## Positions Aero Skye Dual



*Blades closed*





*1 side open*



*Blades rotated*



*2 sides open*

		SQUARE DESIGN	
		AERO® LINE	
TYPE		Aero®	Aero Skye®
			1. AERO SKYE® 2. AERO SKYE® Dual
			
ROOF FILL		Rotating blades	Rotating and retractable blades
<b>DIMENSIONS</b>			
	Max. width / pivot	6055 mm	6200 / 11750 mm**
	Max. depth / span	4500 mm	4500 mm
	Max. passage height	-	-
	Joinable	-	-
	Min. slope	no slope (0°)	
	Max. blade rotation	150°	145°
<b>ACCESSORIES</b>			
SIDE PROFILES	Integrated Fixscreen	-	-
	Fixscreen surface mounted	-	-
	Loggia sliding panels	-	-
	Quick passage Loggiascreen Canvas	-	-
	Glass walls	-	-
	Linius wall passage height	-	-
	Linius wall as railing	-	-
	Triangle	-	-
	Outdoor curtains	-	-
	Additional column	-	-
	Shifted column	-	-
Adjustable wall profile	-	-	
LIGHTING	Lineo LED	optional	-
	UpDown LED	optional	optional
	Colomno LED	-	-
	Lapure LED	-	-
	Lagune LED	-	-
	Toscane LED	-	-
COMFORT & DESIGN	Beam Heat & Sound	optional	optional
	Translucent blades Lineo Luce	optional	-
	Wooddesign	optional	optional

\* > 6200 mm is possible with Aero Skye Dual up to max. 11750 mm

You can find all the information about the options and technical specifications in our technical catalogue that you can find in the showroom of your local Renson dealer. For all distribution points, see [www.renson-outdoor.com](http://www.renson-outdoor.com)





Aero®



# LAGUNE®

---

## Characteristics

- Lagune® 36
- Construction situations 37
- Integrated Fixscreen® 37
- Types 37
- Personalization possibilities 39
- Range 40

## Accessories

- Lighting 56
- Heating and music 59

## Side fills

- Side elements 62
- Glass sliding panel 64
- Loggia® sliding panels 66
- Loggia® quick passage / sliding door 70
- Integrated Fixscreen® 71
- Fibreglass fabrics Fixscreen® 73
- Crystal windows 74
- Rensonscreen® Waterproof screen roof 75



# LAGUNE®

---

## Patio cover with innovative translucent fabric in the roof structure

This patio cover consists of an **aluminium structure** with **integrated Fix-screen technology**.

The sun protection fabric is fully integrated into the structure, creating an aesthetic whole. Thanks to its modular structure, the entire unit is easily expendable, even afterwards.

The **Fixscreen technology**, in combination with an **optimal fabric tension**, ensures that rainwater is discharged to guiding ducts that are hidden in the structure.

Even if the fabric of the sun protection is not completely rolled out, the water that falls on it is removed by this **integrated water drainage system**.

A lot of attention was also paid to the **quality of the finishing**. For example, fixation parts are **virtually invisible**, all electrical cables are concealed, and it is even possible to place an invisible ground mounting.

Due to the high quality materials used and Lagune's design itself, **maintenance is kept to a minimum**, while at the same time guaranteeing **exceptional durability**.

The availability in all RAL colours and the various personalization possibilities make Lagune fit in **any architectural style**.



*Integrated water drainage*



*Integrated water drainage*

### Construction situations



**Construction situation 1** - Against rear structure (standard)



**Construction situation 2** - Against rear left and right structure



**Construction situation 3** - Against rear and left structure



**Construction situation 4** - Against rear and right structure

### Types

Depending on Lagune width, 4 basic models are available:



**Base model 1**  
1500 mm < width ≤ 4000 mm



**Base model 2**  
4000 mm < width ≤ 6000 mm



**Base model 3**  
6000 mm < width ≤ 8000 mm



**Base model 4**  
8000 mm < width ≤ 12000 mm

### Integrated Fixscreen®

By integrating the vertical sun protection, the integrated Fixscreen, whether or not equipped with Crystal windows to retain the view outwards, you can create an additional outdoor area where you are protected from sun, rain and wind. These screens are available in 50 colours and allow you to **personalize** the Lagune and create the atmosphere you want.



Lagune equipped with multiple integrated Fixscreen in the Front

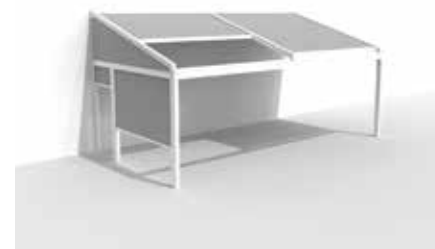

Lagune equipped with multiple integrated Fixscreen in the Side

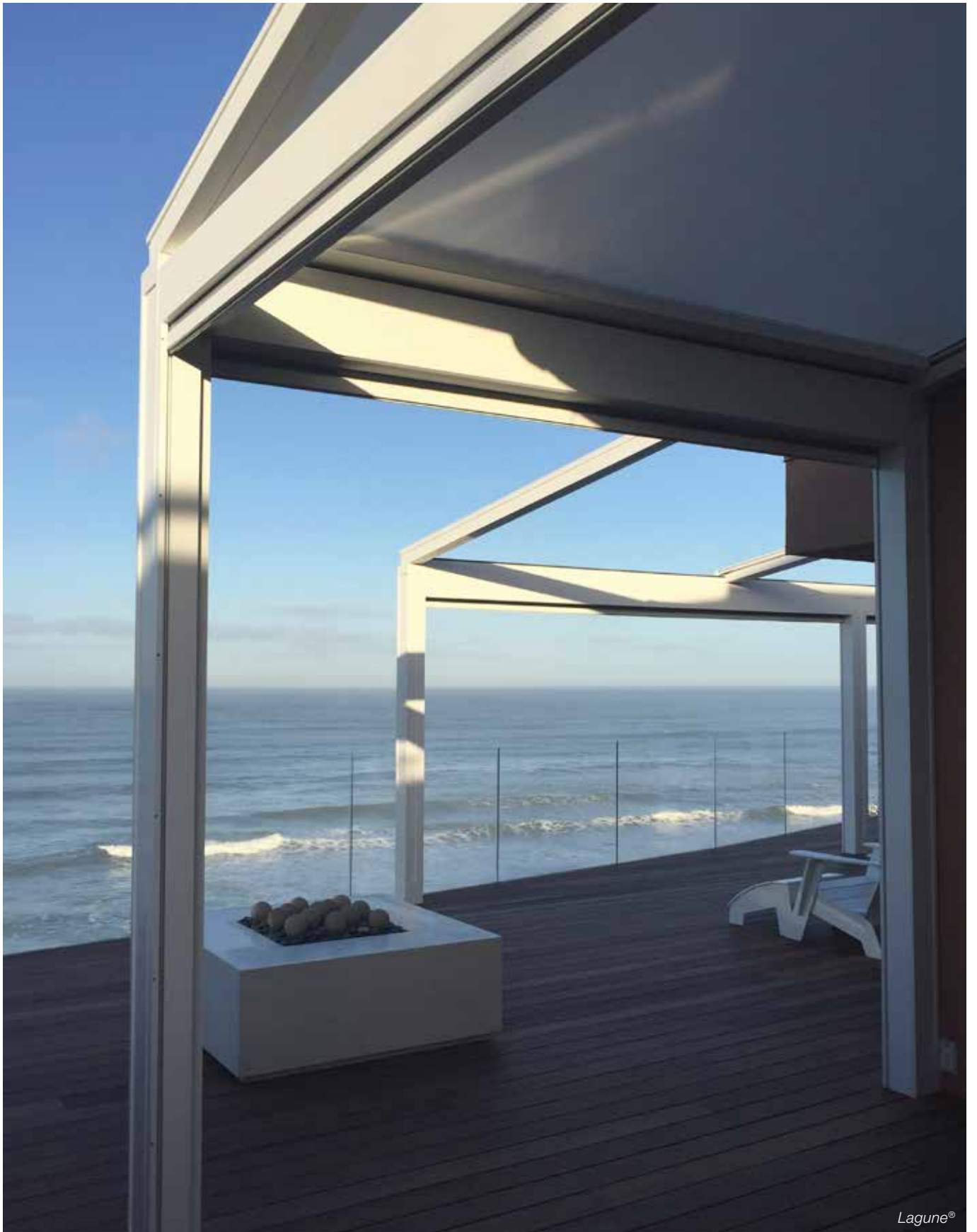

Lagune®

### Personalization possibilities

Lagune can be fitted with various elements on the front and/or sides. By adding side elements, endless customisation possibilities are generated.



*Triangle*



*Integrated Fixscreen*



*Glass sliding panel*



*Loggiawood sliding panels/ Loggialu wooddesign/ Loggiascreen Canvas / Loggialu / Loggialu Stirata / Loggialu Plano / Loggiawood Linea*



*Quick passage Loggia: Loggiascreen Canvas*

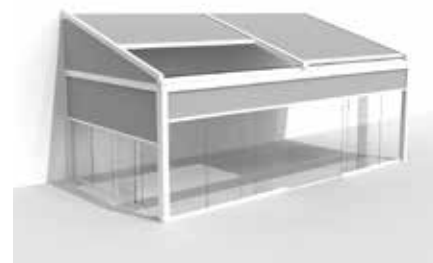

*Glass sliding panel + integrated Fixscreen*

### Triangle - Lagune®

To enable the integration in Lagune Side, it is necessary to equip it with Lagune Triangle. For this, the Lagune is fitted with a vertical wall profile and an additional box. The triangle that is created between the box and the cross member of the Lagune is filled with a chosen glass fibre fabric.



*Lagune®*

		INCLINED DESIGN
TYPE		LAGUNE®
		Lagune®
		
ROOF FILL		Rollable waterproof translucent sun protection fabric
<b>DIMENSIONS</b>		
Max. width / pivot		6000 mm
Max. depth / span		6200 mm
Max. passage height		2500 mm
Joinable		up to max. width 12m
Min. slope		8°
Max. blade rotation		-
<b>ACCESSORIES</b>		
SIDE PROFILES	Integrated Fixscreen	optional
	Fixscreen surface mounted	-
	Loggia sliding panels	optional
	Quick passage Loggiascreen Canvas	optional
	Glass walls	optional
	Linius wall passage height	-
	Linius wall as railing	-
	Triangle	optional
	Outdoor curtains	-
	Additional column	optional
	Shifted column	-
Adjustable wall profile	-	
LIGHTING	Lineo LED	-
	UpDown LED	-
	Colomno LED	-
	Lapure LED	-
	Lagune LED	optional
	Toscane LED	-
COMFORT & DESIGN	Beam Heat & Sound	optional
	Translucent blades Lineo Luce	-
	Wooddesign	-



You can find all the information about the options and technical specifications in our technical catalogue that you can find in the showroom of your local Renson dealer. For all distribution points, see [www.renson-outdoor.com](http://www.renson-outdoor.com)





Lagune®



# LAPURE®

---

## Characteristics

- Lapure® 44
- Types 45
- Personalization possibilities 45
- Range 46

## Accessories

- Lighting 56
- Heating and music 59

## Side fills

- Side elements 62
- Loggia® quick passage / sliding door 70
- Surface mounted fixscreen® 70
- Fibreglass fabrics Fixscreen® 72
- Crystal windows 74
- Rensonscreen® Waterproof screen roof 75



# LAPURE®

---

## Minimalist patio cover with water- and sun protection Fixscreen® screening roof

The stylish and **minimalistic** Lapure consists of a windproof, sun and waterproof screen roof that rests on elegant, discrete aluminium columns **without a disturbing lateral connection** and is anchored to an existing façade.

When the roof is closed, Lapure offers shelter from the sun, wind and rain. With an open roof, one can enjoy the sun while the **light structure** does not disturb visually.

There are two types of columns for the Lapure; **'end columns'** with water drainage (via side channels and columns, even in half open position). It is also possible to select **'shifted columns'** (with eaves and water discharge via spouts, even in half open position). In the latter case, the roof extends beyond the columns to optimally enjoy shading. This allows you to still enjoy plenty of shade, for example when the sun is low (installations on a west façade).

A **'joined'** version is also possible, so that two or more roofs can be placed next to each other perfectly to cover large dimensions (only 1 column when joined).

Thanks to the wide choice of colours for the structure and fabrics, Lapure fits into any environment and architectural style.

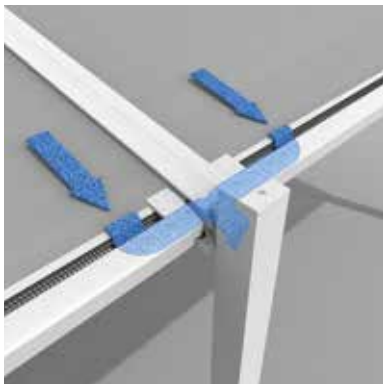

*Joined version with end column*

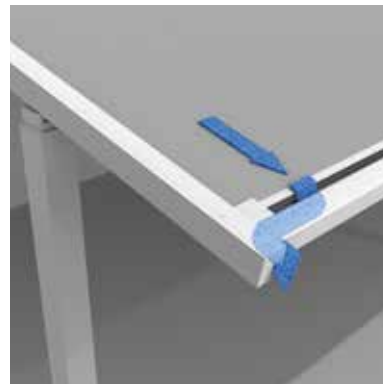

*With shifted column*

## Types

### 1 roof part

Without eaves  
(with 'end columns')

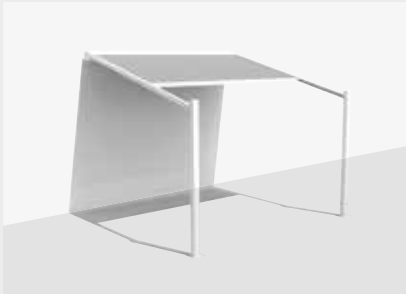

With eaves  
(with 'shifted' columns)



### 2 roof parts



### 3 roof parts

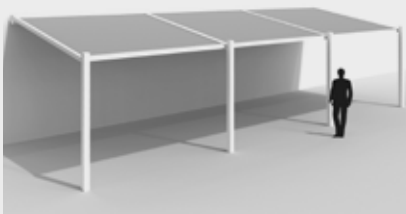

## Personalization possibilities

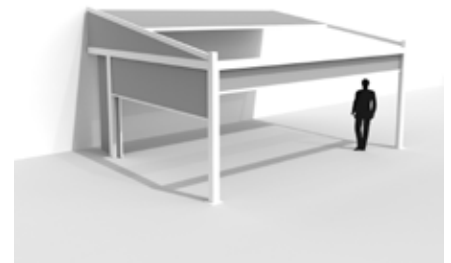

Lapure with Fixscreen and sliding door  
Loggiascreen Canvas in the Side

1 roof section between 4 to 6 m:  
including crossbar (with or without  
LED)



Lapure 'Classic Line' creates a classic, traditional style by adding decorative elements: stylised columns and pions in spherical or diamond shapes.



		INCLINED DESIGN	
TYPE		LAPURE® Lapure®	
			
ROOF FILL		Rollable waterproof translucent sun protection fabric	
<b>DIMENSIONS</b>			
Max. width / pivot		6000 mm***	
Max. depth / span		5000 mm	
Max. passage height		2900 mm	
Joinable		up to max. width 18m	
Min. slope		10°	
Max. blade rotation		-	
<b>ACCESSORIES</b>			
SIDE PROFILES	Integrated Fixscreen	-	
	Fixscreen surface mounted	optional	
	Loggia sliding panels	-	
	Quick passage Loggiascreen Canvas	optional	
	Glass walls	-	
	Linus wall passage height	-	
	Linus wall as railing	-	
	Triangle	optional	
	Outdoor curtains	-	
	Additional column	optional	
LIGHTING	Lineo LED	-	
	UpDown LED	-	
	Colomno LED	-	
	Lapure LED	optional	
	Lagune LED	-	
	Toscane LED	-	
	COMFORT & DESIGN	Beam Heat & Sound	-
Translucent blades Lineo Luce		-	
Wooddesign		-	

\* \*\* up to 4000 mm without cross beam, > 4000 mm to 6000 mm with cross beam

You can find all the information about the options and technical specifications in our technical catalogue that you can find in the showroom of your local Renson dealer. For all distribution points, see [www.renson-outdoor.com](http://www.renson-outdoor.com)











# TOSCANE®

---

## Characteristics

- Toscane® 50
- Joinable 51
- Personalization possibilities 51
- Range 52

## Accessories

- Lighting 56

## Side fills

- Side elements 62
- Glass sliding panel 64
- Loggia® sliding panels 66
- Integrated Fixscreen® 71
- Surface mounted fixscreen® 72
- Fibreglass fabrics Fixscreen® 73
- Crystal windows 74
- Rensonscreen® Waterproof screen roof 75

# TOSCANE®

---

## **Sleek, modular patio cover with retractable folding roof, powered by patented technology**

Toscane is sun protective, rainproof and windproof and has an integrated water drainage system.

Large dimensions, with a maximum width of 6500 mm projection x 13000 mm width with a 1 piece roof are possible, making this product perfect for the hospitality/catering industry.

In Toscane, an inclination of slope of 4° to 20° is possible, depending on the span.

Moreover, various side fills can be integrated: Fixscreen, glass walls such as Loggia sliding panels. Various roof screen types are available: translucent or opaque.

Toscane can be supplied with integrated LED lighting for durable and atmospheric light.



**Joinable**



*2 sections joined with small front beam*

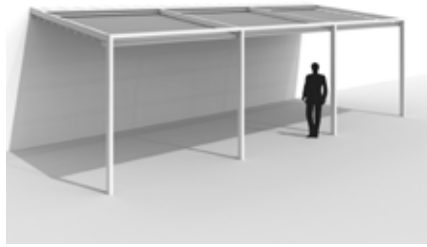

*3-jointed with small front beam*



*2-jointed with a large front beam for integration of Side elements*

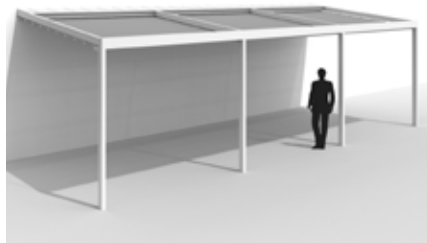

*3-jointed with a large front beam for integration of Side elements*

**Personalization possibilities**

Toscane can be fitted with various elements on the front and/or sides. By adding side elements, endless customisation possibilities are generated.

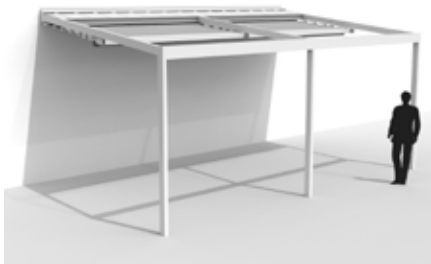

*Without infills*

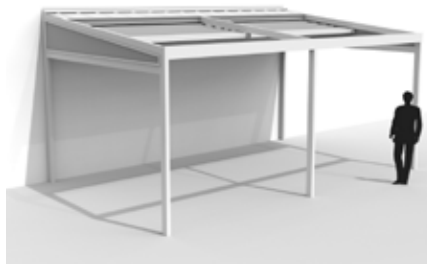

*With triangle*



*With integrated Fixscreen*



*With integrated Loggia panels*

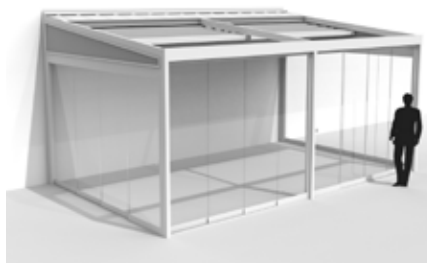

*With integrated glass sliding panels*

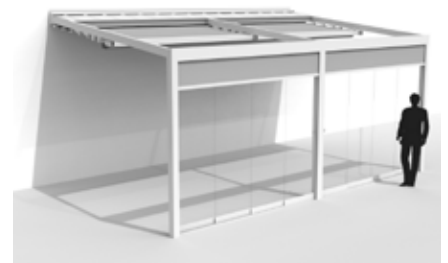

*With integrated Fixscreen and glass sliding panel*

INCLINED DESIGN

TOSCANE®

Toscane®

TYPE



<b>ROOF FILL</b>		<b>Folding roof</b>
<b>DIMENSIONS</b>		
Max. width / pivot		4500 mm
Max. depth / span		6500 mm
Max. passage height		2500 mm
Joinable		up to max. width 13m
Min. slope		from 4° (depending on the width)
Max. blade rotation		-
<b>ACCESSORIES</b>		
<b>SIDE PROFILES</b>	Integrated Fixscreen	optional
	Fixscreen surface mounted	optional
	Loggia sliding panels	optional
	Quick passage Loggiascreen Canvas	-
	Glass walls	optional
	Linius wall passage height	-
	Linius wall as railing	-
	Triangle	optional
	Outdoor curtains	-
	Additional column	-
<b>LIGHTING</b>	Shifed column	-
	Adjustable wall profile	-
	Lineo LED	-
	UpDown LED	-
	Colomno LED	-
	Lapure LED	-
<b>COMFORT &amp; DESIGN</b>	Lagune LED	-
	Toscane LED	optional
	Beam Heat & Sound	-
	Translucent blades Lineo Luce	-
	Wooddesign	-



You can find all the information about the options and technical specifications in our technical catalogue that you can find in the showroom of your local Renson dealer. For all distribution points, see [www.renson-outdoor.com](http://www.renson-outdoor.com)

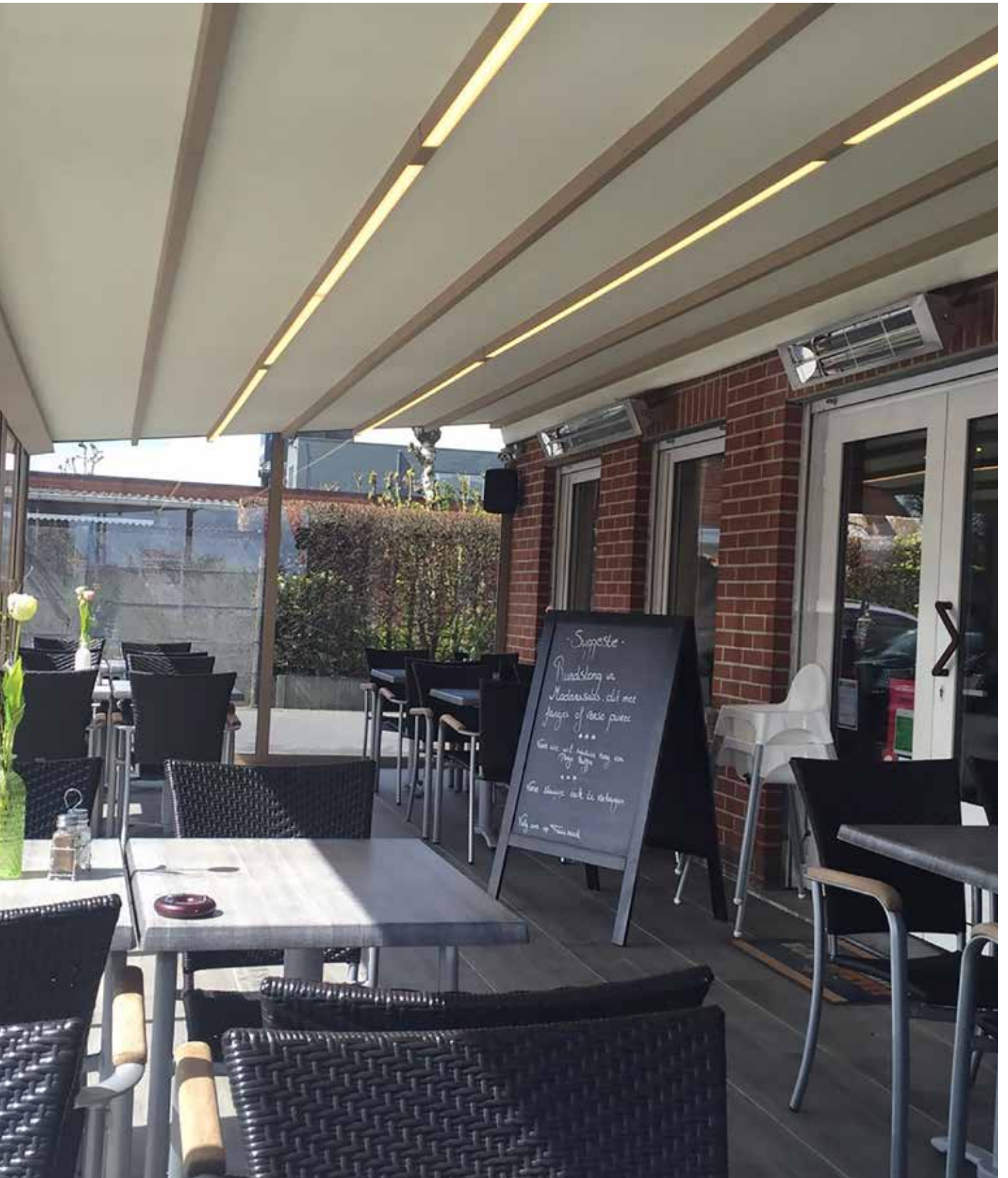



Loggiawood®

Fixscreen®

Lighting

# ACCESSORIES

---

## Accessories

- Lighting 56
- Heating and music 59
- Translucent blades - Lineo® Luce 60

## Side fills

- Side elements 62
- Outdoor curtains 63
- Glass sliding panel 64
- Loggia® sliding panels 66
- Linius Wall 68
- Loggia® quick passage / sliding door 70
- Integrated Fixscreen® 71
- Surface mounted fixscreen® 72
- Fibreglass fabrics Fixscreen® 73
- Crystal windows 74
- Rensonscreen® Waterproof screen roof 75

Heating  
and music



# LIGHTING, HEATING AND MUSIC

ENJOY AT ANY TIME OF THE DAY

When it gets dark in the evening, you turn on the integrated **lighting**. The choice of light allows you to create the desired look and feel.

Even when it gets colder, you can still continue to enjoy the outdoors. **Thermal comfort** can be provided for this purpose.

The radiant heat ensures a smooth heat distribution within the room with minimal heat loss.

Even your favourite **music** can be heard on your terrace without any problems due to the integrated speakers.

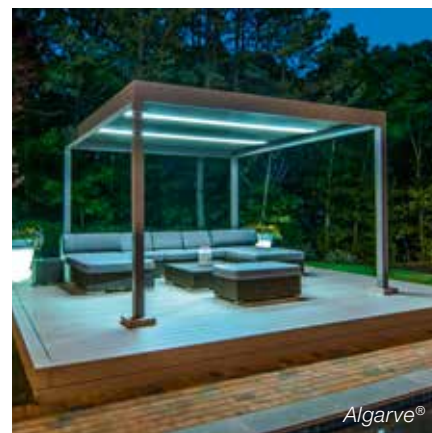

## A | Lighting

Being able to choose bright or warm white light allows you to create the desired look and feel. Also, the LED lighting can be **dimmed** in most coverings, so that the light intensity can be adjusted to the situation.

In **Lagune**, **Lapure** and **Toscane**, the lighting is integrated into the roof structure.

For the **Camargue Line**, **Algarve Line** and **Aero Line**, you can choose LED

lighting in the roof blades and can place both upward and downward lighting on the inside of the frame. The **Camargue** and **Camargue Skye** can even be fitted with atmospheric lighting in the columns.

You can choose between warm white (ideal for socializing with friends), pure white light (ideal for reading a book for example) and RGB (only with upward lighting on the frame), so that the de-

sired atmosphere, the perfect look and feel can be created. The LED lighting can also be dimmed so that the light intensity can be adjusted to the situation. The exceptional durable quality of the Renson® LED lighting ensures uniform lighting without any dots.

**Algarve Canvas**, **Camargue Skye** and **Aero Skye** can be equipped with atmospheric UpDown LED lighting.

	Warm white light	Pure white light	RGB (colour)	Dimmable
Lagune® LED Light*	✓	✓		✓ (io)
Lineo® LED Light*	✓	✓		✓
Colomno LED Light**	✓	✓		✓
UpDown LED Light** Up	✓	✓	✓	✓
UpDown LED Light** Down	✓	✓		✓
Toscane® LED Light*	✓	✓		✓
Lapure® LED Light*	✓	✓		✓

\* Warm white: 2100 lm/m (180 LEDs/m) / Pure white: 2340 lm/m (180 LED's/m)

\*\* Warm white: 550-680 lm/m (120 LED's/m) / Pure white: 550-680 lm/m (120 LED's/m) / RGB: 570-700 lm/m (60 LED's/m)



### Colomno LED Light



Integrated LED lighting in the columns - **Camargue Line**. For each column, a maximum of one LED strip can be integrated (on the inside of the column). Maximal four columns can be fitted with integrated LED Light lighting per roof part.



### UpDown LED Light

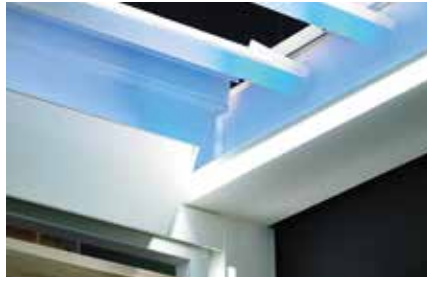

Integrated LED lighting on the inside of the frame. Equipped with upward and/or downward lighting. This will provide indirect or direct soft/ambient lighting in the **Camargue Line**, **Algarve Line** and **Aero Line**. Per roof part, up to two UpDown LED lighting modules can be fitted. This to either on the Pivot side, or the Span side.



### Lagune® LED Light



Integrated LED lighting in the side beams of the Rooffix - **Lagune**.

### Lineo LED Light



Integrated LED lighting in the blades - **Camargue**, **Algarve** and **Aero**. Even spreading of light without visible dots due to the high quality LEDs (180 per meter).

### Toscane® LED Light



Integrated LED lighting in the roof profile in pure or warm white. The LEDs are not dimmable.

### Lapure® LED Light



Integrated LED lighting in the crossbar of the Lapure.



## B | Heating and music

Integrated LED Light lighting, heating and sound are the perfect addition to **Camarague Line, Algarve Line, Aero Line** and **Lagune**. Due to these additional features, the terrace can be used from early morning to late evening, all year round.

The Beam is also available separately. These extensions can also be integrated perfectly afterwards.

### Beam design bar with Heat & Sound



Integrated heating elements and speakers

### Heating in combination with a side element

For optimal enjoyment of the heater, a side element (through a glass wall, Fixscreen, ...) of the patio cover is recommended.



### Ideal position of the heater

The ideal position of the heater is opposite a fixed wall so that one can enjoy the reflective heat.



### After how much time do you have maximum heat from the heater?

Because we work with short wave system, you have almost instant maximum heat radiance of the heater. Short wave radiation is felt immediately, compared to heat from the sun. You warm up the objects and not the area.

Long wave infra-red heaters have a longer warm-up time than the short wave heaters. They need space to create heat. Depending on the ambient temperature, the size of the covering, closed or not,... it may take a certain amount of time before you can feel this radiation as much as possible.

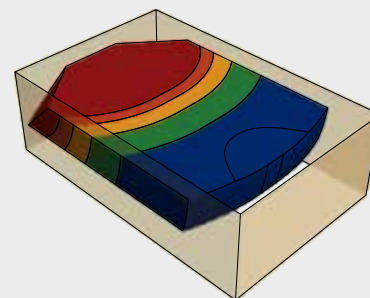

Heat effect with 1 side heated (size 6 x 4 m)

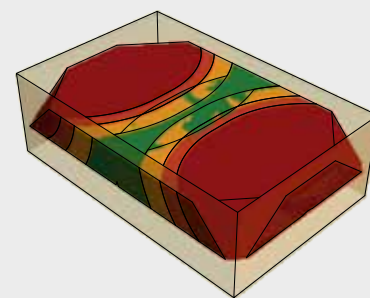

Heat effect with 2 sides heated (size 6 x 4 m)

# TRANSLUCENT BLADES - LINEO<sup>®</sup> LUCE

(FOR CAMARGUE<sup>®</sup>, ALGARVE<sup>®</sup> AND AERO<sup>®</sup>)

---

## Reinforcing elegance through translucent blades

For **Camargue**, **Algarve** and **Aero**, equipped with tiltable aluminium blades; Renson<sup>®</sup> offers the possibility to integrate translucent **glass blades**, namely the Lineo Luce. By partially providing your patio cover with translucent blades, more openness is created. This allows more light to enter when you extend your home.

Per roof part, up to 5 translucent blades can be placed with a maximum width of 4 m. These can either all be placed next to each other or spread out over the entire roof section.

Ideal for still having light when the roof is closed!





*Light in the house when the roof is closed*



*Light under the patio cover with closed roof*



# SIDE ELEMENTS

---

## Endless personalization possibilities

All coverings can be fitted with different elements (such as sun protection fabric, sliding panels, glass walls, etc.) on the front and/or sides. This creates endless personalization possibilities.

The front and/or sides can be equipped with vertical sun protection fabric.

**Lowered, windproof and motorised Fixscreens** provide a protective cocoon. Thanks to the partial transparency of the fabrics and possibly Crystal windows, the view of the garden is always

maintained. Furthermore, you can also choose from a wide range of colours. All colour combinations are possible and can be perfectly combined with other materials such as garden furniture. In open position, the **screens are invisibly integrated** and the motors are completely hidden in the structure.

You can also opt for **glass sliding panels**. In combination with windproof screens, the advantage of sun protection is also maintained.

Elegant **Loggia sliding panels with windproof screen fabrics or wooden or aluminium blades (whether tilting or not)** are among the possibilities. Wood (ceder) is completely back again and can easily be combined with other materials.

In the case of sliding panels with aluminium blades, you can even opt for a bi-colour version.



# OUTDOOR CURTAINS

(FOR CAMARGUE® LINE AND ALGARVE® LINE)

## Equipped with curtains for outdoor use

Both **Camargue Line** and **Algarve Line** can be equipped with outdoor curtains. This creates an enchanting atmosphere under the covering.

These polyester curtains for outdoor use are waterproof, fungicide and dirt-repellent.

They also offer lasting weather resistance and colour-fastness, even after washing. And it is completely shrink-free.

The curtains are delivered perfectly tailored.

Moreover, they can be combined in the Camargue Line with glass sliding panels and integrated Fixscreens.

The outdoor curtains are always used in combination with UpDown LED lighting. This is why the patio cover creates a romantic atmosphere during the evening.



# GLASS SLIDING PANEL

(FOR CAMARGUE® LINE, ALGARVE® LINE, LAGUNE® AND TOSCANE®)

---

## Reinforcing elegance through fully transparent sliding panels

You can also choose to place glass sliding panels. These completely translucent sliding panels accentuate the elegance of the **Camargue Line**, **Algarve Line**, **Lagune** and **Toscane**. These also offer protection against wind and weather and the patio cover can be made closable against theft.

Next to a glass sliding panel, it is also still possible to integrate the vertical windproof sun protection **Fixscreen**, which preserves the great advantage of sun protection.

Moreover, you can also combine the glass wall with the outdoor curtains, even with the integrated **Fixscreens**.

### Integration

**Camargue Line & Algarve Line:** possible in Span and/or Pivot

**Lagune and Toscane:** possible in Side and/or Front



Lagune®





The Camargue Line features glass sliding panels and integrated Fixscreen in the Span and Pivot side

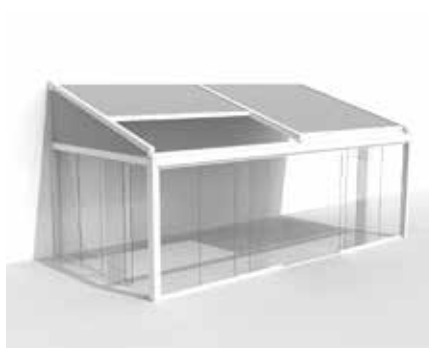

Lagune features glass sliding panels in the Side and Front



Lagune features glass sliding panels and integrated Fixscreen in the Side and Front

**DISTRIBUTION GLASS SLIDING**

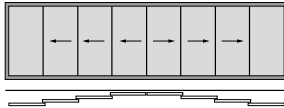
			
$1500 \leq X \leq 2500$ mm Width X	$2500 < X \leq 3750$ mm Width X	$3750 < X \leq 5250$ mm Width X	$5250 < X \leq 6500$ mm Width X
3 panels	4 panels	6 panels	8 panels
3 tracks	4 tracks	3 tracks	4 tracks
Open left or open right	Open left or open right	Open left and open right	Open left and open right
Incl. 1 handle	Incl. 1 handle	Incl. 2 handles	Incl. 2 handles

# LOGGIA® SLIDING PANELS

(FOR CAMARGUE® LINE, ALGARVE® LINE, LAGUNE® AND TOSCANE®)

## Affect lighting yourself

With the sun protecting vertical sliding panels, you can influence the light entry underneath the patio cover yourself (dy-

amic sun protection). The sun protection sliding panels are constructed from aluminium frames with:

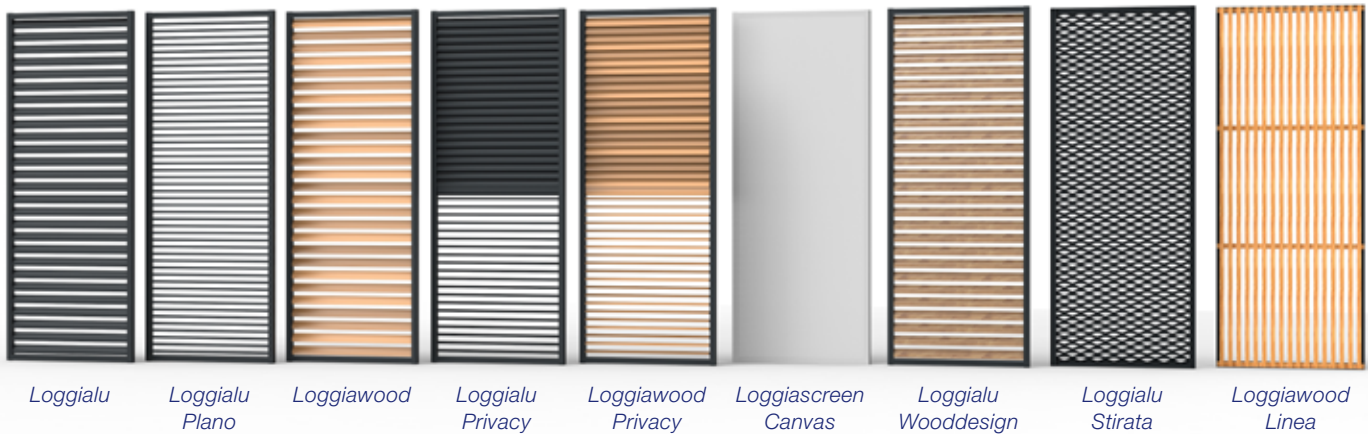

### Privacy

Manually tiltable wooden or aluminium blades. With the **Privacy** version of the Loggiawood and Loggialu sliding panels, the blades can be manually rotated to a fully closed or open position.





*Camargue Line features Loggia wood sliding panels in the Span side*



*Lagune equipped with Loggia wood sliding panels in the Side*

### Types

- Loggia wood: wooden blades (WRCedar)
- Loggia wood Privacy: wooden rotatable blades (WRCedar)
- Loggiascreen Canvas: fabrics (fibreglass)
- Loggialu: aluminium blades
- Loggialu Privacy: aluminium rotatable blades
- Loggialu wooddesign: aluminium blades with Wooddesign
- Loggialu Stirata
- Loggia wood Linea

### Camargue Line integration:

possible in span and/or pivot

**Algarve Line:** possible in span and/or

pivot up to 4500 mm

**Lagune:** possible in Side

**Toscane:** possible in Front

### Wooddesign

Camargue Line, Algarve Line and Aero Line, equipped with wooddesign aluminium roof blades

- Natural look and feel of wood, combined with the advantages of aluminium regarding:
  - Easy maintenance
  - Colourfast
  - Shape retention
- Also available for the LED blades
- Can be perfectly combined with the Loggialu Wooddesign sliding panels
- Roof blade in wooddesign (frame and columns in normal coating)
- Available in 3 types:
  - White oak
  - Natural oak
  - Walnut



*White oak*



*Natural oak*



*Walnut*

# LINIUS WALL

(FOR CAMARGUE® LINE AND ALGARVE® LINE)

---

## Physical limitation or decorative finishing of a rear wall

With the Linius wall cladding, fitted in the Algarve Line or Camargue Line, you will get a physical limitation or a decorative finishing of a rear wall.

The Linius fixed wall is available as a single-sided or double-sided clad wall over the entire passage height, or can be finished at a height as desired with a top profile to create a balustrade. Ideal as a surrounding for catering terraces or balconies.

The supporting structure provides an invisible connection of the finishing blades, so that the lines are uninterrupted across the entire passage clearance.

Both at the front and the back, the wall is beautifully situated in the columns. Height differences in the floor of up to 6 cm are covered by the finishing skirt, so that no annoying openings are visible at the bottom.

The Linius wall is customised in the colour of the covering or a colour of your choice. Moreover, the double-sided wall offers the possibility for sound insulation. This allows you to enjoy nature in peace and quiet around your covering.



*Linius fixed wall bar  
height double-sided*

*Linius fixed wall full height  
single or double-sided*



# LOGGIA® QUICK PASSAGE / SLIDING DOOR

(FOR CAMARGUE® LINE, LAGUNE® AND LAPURE®)

Ideal if the patio cover is completely enclosed (e.g. by Fixscreen) and you want a quick passage to or from the patio cover, without having to open the Fixscreen (no loss in comfort for those sitting under the patio cover).

The quick passage consists of an aluminium frame covered on one side by a fibreglass screen fabric of your choice.

## Integration

**Camargue Line:** possible in span and/or pivot.

**Lagune:** possible in Side and/or Front

**Lapure:** possible in Side and/or Front  
Width: min. 800 mm - max. 1200 mm



*Camargue equipped with integrated Fixscreen and sliding door by means of Loggiascreen Canvas in the Span side*



*Lagune equipped with integrated Fixscreen and sliding door by means of a Loggiascreen Canvas in the Side*



*Lagune equipped with integrated Fixscreen and sliding door by means of a Loggiascreen Canvas in the Front*

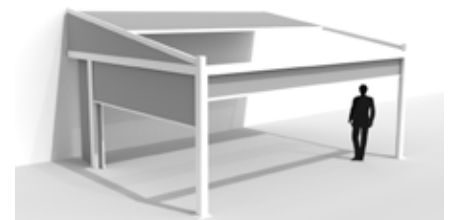

*Lapure with Fixscreen and sliding door by way of Loggiascreen Canvas in the Side*



# INTEGRATED FIXSCREEN®

(FOR CAMARGUE® LINE, LAGUNE® AND TOSCANE® FRONT)

## Perfect integration, even afterwards!

Ideal for:

- Privacy
- Shadow at low sun position
- Protection against wind, rain and insects

Thanks to an ingenious zip system, the fabric is windproof in every position and the screen is insect repellent in closed position. It's a very ingenious principle whereby the solar protection fabric has a special trim with a zip. This keeps the entire structure firmly embedded in the two side channels.

By integrating this Fixscreen, whether or not equipped with Crystal windows

to maintain the view to outside, you can create an additional outdoor area where one is sheltered from sun, rain and wind. These screens are available in more than 50 colours and allow you to personalize the Camargue Line, Lagune and Toscanne and create the atmosphere you want.

### Connect&Go technology

The integrated Fixscreen is equipped with our patented Connect&Go technology. This new development offers an enormous advantage for the installation, and also regarding disassembly of the fabric roller barrel for replacing a fabric or motor.

### Bottom bar disappears fully into the box

The frame profile of the Camargue Line has been developed in a way that the bottom bar is aesthetically hidden in the box. Perfect integration, even afterwards!



Bottom bar disappears fully into the box

## Personalized printing

Next to the standard fabric range, a photo can be printed on the fabrics to personalize a screen under a pa-

tio cover. This includes both printing of the company logo, as well as your own design.



FIXSCREEN TECHNOLOGY  
WARRANTY

\* 5-year warranty on the Fixscreen-technology in stand-alone applications Fixscreen

# SURFACE MOUNTED FIXSCREEN®

(FOR ALGARVE® LINE, TOSCANE® SIDE AND LAPURE®)

---

## Fencing of the sides

To close off the sides of Algarve, Toscane or Lapure, it is possible to combine them with the Fixscreen 100 <sup>EVO</sup> Slim F or the Fixscreen 150 <sup>EVO</sup> F.

The sun protection box can be mounted on the frame profile, which perfectly matches the base structure.





# FIBREGLASS FABRICS FIXSCREEN®

(CAMARGUE® LINE, ALGARVE® LINE, LAGUNE®, TOSCANE® AND LAPURE®)

## Sun protection and translucent fabric

The best choice of sun protection and light-permeable fabric for windproof vertical sun protection is a fiberglass fabric. Fiberglass fabrics score best in terms of tightness, shape retention, are highly resistance to humidity and heat and retain the view to outside.

We offer a wide range of colours to choose from, so that the perfect fabric can be chosen to suit your taste.

The "architects' selection" is a collection of colours that are highly sought-after according to current trends in design and architecture.

Our Renson® Ambassadors are happy to accompany you in your choice. The fiberglass fabrics are also available with a Crystal window for crystal clear viewing.

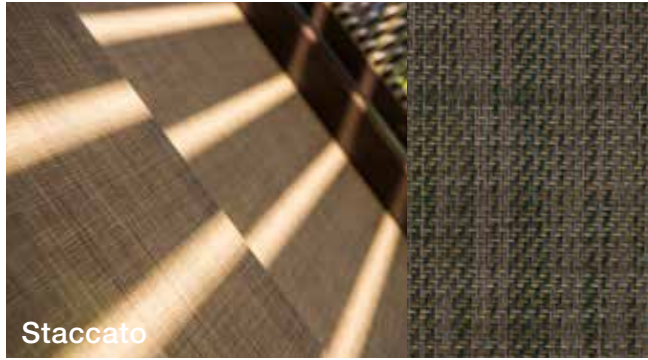

*Staccato: applicable only to Loggiascreen Canvas*

# CRYSTAL WINDOWS

## Optimal contact with the outdoor area

In order to maintain optimum contact with the outdoor area, transparent Crystal windows can be placed in glass fibre fabric of the integrated Fixscreen. This transparent screen fabric consists of PVC (Fire classification M2). The Crystal fabric is high-frequency welded in a fibreglass fabric. This fabric can be used in the integrated Fixscreen, Fixscreen 100<sup>EVO</sup> Slim F and the Fixscreen 150<sup>EVO</sup> F.

There are various options that allow you to choose between 2 window variants:

- One 1200 mm window on min. 1200 mm
  - 2 windows\* next to each other
- Up to 2 Crystal windows can be integrated per screen. Keep a minimum distance of 200 mm from the sides of the fabric and between the Crystal windows. Maintain a distance of 400 mm between the Crystal windows and the bottom and top side of the fabric.

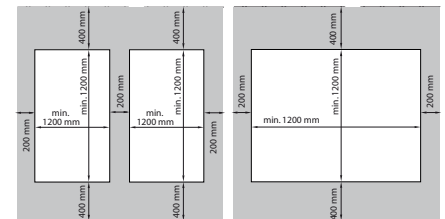

\* Either height or width must be 1200 mm. The other dimension must be min. 1200 mm.



# RENSONSCREEN® WATERPROOF SCREEN ROOF

(LAPURE®, LAGUNE® AND TOSCANE®)

The roof of **Lapure**, **Lagune** and **Toscane** are equipped with an innovative waterproof, sun protection and translucent fabric. These polyester fabrics are coated on one side with a UV-resistant waterproof coating. This fabric is available in different colours.



## Rensonscreen® Waterproof



\* Exclusive colours

The roof of **Algarve Canvas** is finished with a unique patented tension ceiling. Fibreglass fabric is stretched by using the proven Fixscreen technology in the frame for a horizontal, seamless and clean finishing of the ceiling without interfering cross bars.



## B-screen

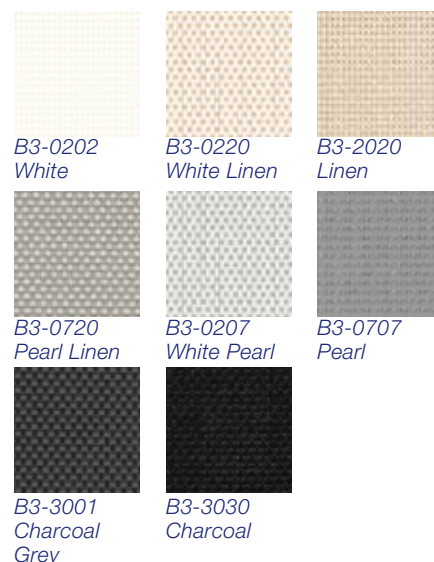

# COLOR CHOICE ALUMINIUM

---

## Available in all standard RAL colours

Our patio covers are powder coated with Seaside Quality pre-treatment as standard. The products are available in all RAL colours in texture version without surcharge.

Renson® recommends textured coating to achieve an architectural, contemporary look. Moreover, textured coating is better suited for outdoor use and scratches are less visible.



# AUTOMATION

---

## Easy remote control

A patio cover can be easily operated with Somfy automation. Control your roof and/or screens of your patio cover with a handheld transmitter. Depending on the desired usage and the number of screens, you can choose from several handheld transmitters.

Thanks to TaHoma, Somfy's new control interface, your patio cover can be controlled from your Smartphone, tablet or computer.

For optimal comfort, we recommend installing a rain and/or wind sensor.



somfy.

# WEATHER RESISTANCE

---

## Closable against rain and wind

Lapure and Lagune are patio covers with sun protection, waterproof and translucent fabric. The Fixscreen technology, combined with an optimal fabric tension, ensures that rainwater on the fabric is drained via hidden ducts. Even if the fabric of the sun protection is not completely rolled out, the water that falls on it is removed by this integrated water drainage system.

Camargue Line, Algarve and Aero Line are patio covers with a roof of rotatable blades. These patented blades are designed in such a way that, even if the blades open after a rain shower, the water is led off to the side.



*The Lagune can process a precipitation flow rate that corresponds to a rain shower with an intensity of 180 mm/h that lasts max. 2 minutes. This type of rain shower occurs approx. every 15 years. (Cf. Belgian rain statistics: standard NBN B 52-011)*



*The Algarve Line can process a precipitation flow rate corresponding to a rain shower with an intensity of 144 mm/h to 180 mm/h that lasts max. 2 minutes. This type of rain shower occurs approx. every 10 years. (Cf. Belgian rain statistics: standard NBN B 52-011)*



*The Camargue Line can process a precipitation flow rate that corresponds to a rain shower with an intensity of 180 mm/h that lasts max. 2 minutes. This type of rain shower occurs approx. every 15 years. (Cf. Belgian rain statistics: standard NBN B 52-011)*



# TESTING

---

## Protection and comfort

Our patio covers provide protection and comfort on different levels. In order to guarantee this, they are rigorously tested for water drainage, load-bearing capacity and wind resistance.

## Water testing

Water resistance and water drainage are tested with a sprinkler system that mimics rain showers. This way, it is determined how much air flow our patio covers can extract and how this flow can be optimised:

**Camargue Line:** The Camargue Line can process a precipitation flow rate that corresponds to a rainstorm with an intensity of 180 mm/h that lasts max. 2 minutes. This type of rain shower occurs approx. every 15 years. (Cf. Belgian rain statistics: standard NBN B 52-011)

**Algarve Line:** The Algarve Line can process a precipitation flow rate that corresponds to a rain shower with an intensity of 144 mm/h that lasts max. 2 minutes. This type of rain shower occurs approx. every 10 years. (Cf. Belgian rain statistics: standard NBN B 52-011)

**Lagune:** The Lagune can process a precipitation flow rate that corresponds to a rain shower with an intensity of 180 mm/h that lasts max. 2 minutes. This type of rain shower occurs approx. every 15 years. (Cf. Belgian rain statistics: standard NBN B 52-011)



## Bearing capacity

Patio covers are subject to different forces (e.g. snow). The bearing capacity is determined by static strength calculations carried out by our engineers and validated by internal tests.

**Camargue:** at 200 kg load/m<sup>2</sup>, the patio cover remains upright, even with the largest dimensions.

- This corresponds to 2 meters of fresh snow/m<sup>2</sup>.
- This is possible due to the patented frame tensioning system.



200 Kg/m<sup>2</sup>

## Wind tests

Wind tunnel tests were carried out to determine the wind force our patio covers and vertical sun protection can withstand.



	Warranty with closed roof/screen up to	Control roof/screen up to
Camargue® Line	160 km/h 12 Beaufort	50 km/h 7 Beaufort
Camargue Skye® Algarve® Line Aero® Line	120 km/h 11 Beaufort	50 km/h 7 Beaufort
Lagune®	120 km/h 11 Beaufort	50 km/h 7 Beaufort
Lapure®	100 km/h 10 Beaufort	50 km/h 7 Beaufort
Integrated Fixscreen®	60 km/h 7 Beaufort	30 km/h 5 Beaufort
Toscane®	49 km/h 7 Beaufort	30 km/h 5 Beaufort

## Miami-Dade Hurricane resistance

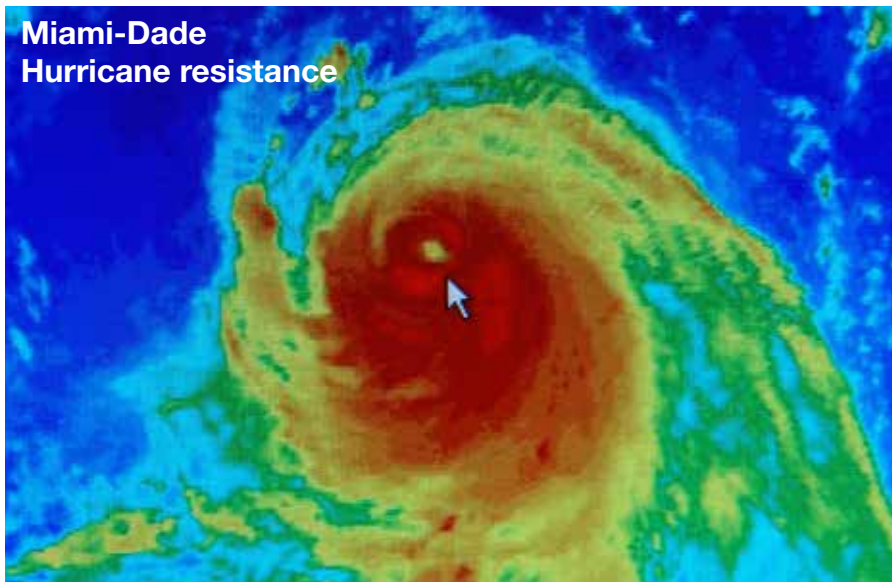

## Beaufort wind scale

Beaufort	Description	Average speed m/s	Average speed km/h	Consequences
0	Windless	< 0,2	< 1	One does not feel the wind. Smoke rises straight up or almost straight up.
1	Pretty weak	0,3 - 1,4	1 - 5	Wind direction can be easily deduced from smokes plumes, but not from the weathervane.
2	Weak	1,5 - 3,4	6 - 12	Wind noticeable in the face, leaves are shivering, the weathervane starts to turn.
3	Pretty moderate	3,5 - 5,4	13 - 19	Waving flag and waving leaves.
4	Moderate	5,5 - 7,4	20 - 27	Windblown dust irritating to the eyes. Hair is messed up.
5	Quite powerful	7,5 - 10,4	28 - 37	Bushes shake, crested waves on lakes and canals.
6	Powerful	10,5 - 13,4	38 - 48	Umbrellas are difficult to hold onto, large branches are swinging and electrical wires are shrieking.
7 FIXSCREEN® TOSCANE®	Hard	13,5 - 17,4	49 - 62	It is difficult to walk against the wind. The trees are swaying.
8	Wind gusts	17,5 - 20,4	63 - 73	Moving is very difficult. Small branches break off.
9	Stormy	20,5 - 24,4	74 - 87	Chimney caps, roof tiles and antennas are blown away.
10 LAPURE®	Heavy storm	24,5 - 28,4	88 - 102	Adults are blown away. Major damage to buildings.
11 ALGARVE® LINE CAMARGUE SKYE® LAGUNE®	Very heavy storm	28,5 - 32,4	103 - 117	Enormous damage to houses and forests.
12 CAMARGUE® LINE	Hurricane	> 32,5	> 118	Devastation and destruction.

# WARRANTY\*

---



WARRANTY



FIXSCREEN TECHNOLOGY  
WARRANTY(\*)



COATING  
WARRANTY

## High quality

All the materials we use are high quality and adapted to the intended use. As a manufacturer we guarantee:

- 5-year(\*\*) warranty against defects that may occur during normal use and maintenance.
- 2-year warranty for electronic control.
- 2-year warranty on crystal fabric.
- For the coating of the aluminium parts, a 10-year guarantee regarding colour fastness applies.
- A 5-year guarantee is given on the gloss of the coated profile.
- 5-year warranty on the Fixscreen-technology: zip stays in side channel + optimal attachment of the zip to screen fabric.

(\*) 5-year warranty on the Fixscreen-technology in stand-alone applications Fixscreen

(\*\*) See our warranty conditions



Register your patio cover  
within 15 days after installation and receive



WARRANTY

[www.renson-outdoor.com/warranty](http://www.renson-outdoor.com/warranty)



\* Colour, gloss and powder coating is warranted for 5 years. If you register the covering and can prove that the covering is cleaned and protected annually with the Renson Maintenance Set, you receive an extended paint warranty to 15 years.



# MAINTENANCE

---

## Easy maintenance with the Renson Maintenance Set

Your patio cover is outside for years, day after day. If you want to enjoy your Renson® covering optimally at all times, we recommend regular maintenance, about 1 to 2 times a year. As a result, the covering will last longer. Do note the following things:

- The texture is made of powder coated aluminium. An annual cleaning with the **Renson Maintenance Set** products ensures years of preserving the intense colour and provides additional protection against acid rain, sea air and UV rays. Maintenance is designated at least 2 x per year in coastal areas and wooded environments.
  - **Renson 'Clean'** is a concentrated product with powerful cleaning and degreasing features for the most common natural pollutants such as dust, greasy precipitation, fat stains, moss, insect tracks,...
  - This product is not comparable with most cleaning products. Because of its in-depth action, the dirt is 'lifted', so to speak. This product can also be used for cleaning polyester fabric roofs and vertical fibreglass screen fabrics.
  - After cleaning, you must protect the aluminium texture with **Renson 'Protect'**. This leaves a protective film that allows subsequent cleaning of the surface area with a simple swipe and minimal use of **Renson 'Clean'**. It also protects the aluminium against acid rain, sea air, UV rays, and thus ensures that the intense colour is retained.
- Both products must not be used in direct sunlight or hot weather. The fast drying of the product could leave stains on the structure or the fabric. Never use corrosive or aggressive products, scouring pads or other abrasives. Furthermore, never use high-pressure devices.

# FAQ & TIPS

---

## Column positions

The **Camargue Line**, **Algarve Line** and **Lapure** can also be ordered with 'shifted' columns. This can be useful if you want to let the patio cover extend beyond the terrace (but the columns are still on the terrace), in order to have complete shading, even in low sunshine.

In case of specific placement or for architectural reasons, one can opt for shifting columns. The column can be shifted up to 1/5th of the total Pivot length.

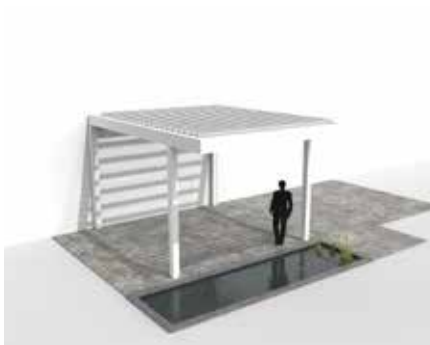
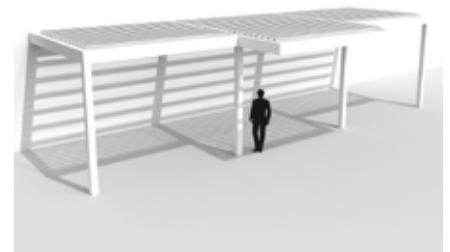
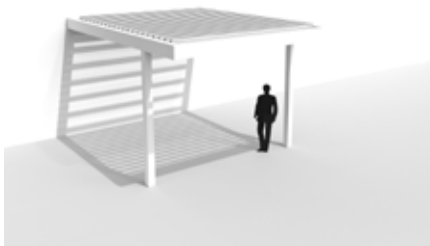
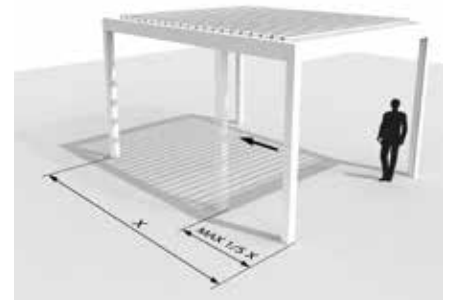

## Turning direction of the blades

With the **Camargue Line**, **Algarve Line** and **Aero Line**, the direction of rotation of your blades is important. Whether you want to keep the sun out for as long as possible or bring in light as soon as possible.

You can choose this with Renson®. For example, when extending a kitchen or living room, people usually want to have light come in as quickly as possible.

- ① By default, the blades rotate to such an extent that sunlight from the south is stopped when the blades are opened. With standard sun protection blades, sunlight can also be drawn in; the blades have to be rotated further.

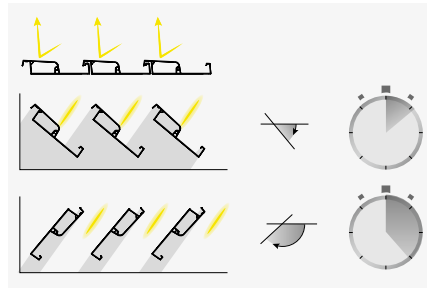

- ① SUN PROTECTION AS STANDARD:  
Stopping sunlight when opening  
(ideal for frequent use in summer)

- ② With sunlight being drawn in by blades, the blades are positioned at the correct angle faster and the flat, beautiful bottom remains visible.

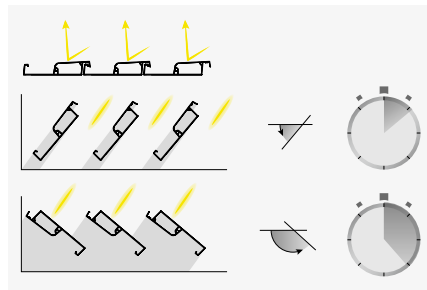

- ② drawing in sunlight when opening  
(ideal for frequent use in winter)

## Colour of the blades

The **Camargue Line**, **Algarve Line** and **Aero Line** are available in dual colour (frame and columns in a different colour than the roof blades) without surcharge.

Tip: choose a lighter colour blades with a darker colour for the structure. A darker colour of the roof blades creates the feeling of a lower ceiling. A lighter colour creates a more spacious feeling and has an additional sun and heat-resistant function.



## Conservatorie

Can a patio cover like the **Camargue Line** or **Algarve Line** be compared to a conservatorie?

No! A conservatorie is a glass extension of the interior and forms a closed unit that is completely wind and rainproof. On the other hand, a patio cover is an open aluminium structure with a roof made of aluminium rotating blades (with optional side panels) that mainly provides protection against the sun and to a certain degree protects against bad weather conditions. In a patio cover, the outside climate predominates and you can enjoy the atmosphere, smells, colours and sounds of the garden.

Underneath a **Camargue Line** or **Algarve Line**, it is best to place weather-resistant garden furniture.

## Wind - Camargue Line and Algarve Line

If a lot of wind is predicted, we recommend closing the louvered roof (possible up to wind speeds of 50 km/h). With a closed louvered roof, the entire structure is sturdier and has better wind resistance. We therefore offer a guarantee on our **Camargue Line** and **Algarve Line** with a closed roof to wind speeds of 120 km/h!

## Fabric or blades?

How do I choose between a patio cover with louvered roof (**Camargue Line** and **Algarve Line**) or with a screen roof (**Lapure** and **Lagune**)?

Every type of patio cover has its own special features. A covering with a sun protection fabric can be fully opened. This way, you can either shut out the sunlight or allow it to fully enter your house, depending on the weather conditions. Patio cover can also be used to control the desired amount of sunlight; if there is excessive sunlight, the blades can be completely closed, but the roof can never be fully opened to allow optimal sunshine.



	Louvered roof	Screen roof
Roof	Horizontal	Constantly under slope
Position	Built-in, recessed or stand-alone	Only built-in
View at 'open' roof	Roof blades rotate open but do not 'disappear'	Roof has completely disappeared
Light with 'closed' roof	Not translucent (except Lineo Luce blades)	Translucent
Bearing capacity	Can carry a snow load	Cannot carry a snow load
Roof colour	All possible colours	Limited choice of colours of roof fabric available

## Low sun: Fixscreen

When the sun is low on the horizon, sunlight can enter the house under the patio cover. This is ideal in the winter to warm up the house naturally. However, sometimes this sunlight can be annoying and dazzling, it discolours materials or reflects in TV and computer screens.

Thanks to vertical fabric sun protection (Fixscreen) in the sides of your patio cover (**Camargue Line** and **Lagune**), the entering sun rays in the interior are stopped. At the same time, contact with the environment is maintained by the transparency of the fabric.

## Passage height

The passage height of a louvered roof (**Camargue Line** and **Algarve Line**) can be freely selected. People usually choose a certain height because of a certain situation (e.g. in an installation/construction situation, a rain gutter or window can be in the way) or for personal reasons; a person with a large stature will prefer a higher passage height to obtain a certain 'openness'. On the other hand, for the best shading, it is best to have the lowest possible passage height.



## Terrace orientation

Depending on the orientation of the terrace, a covering can also be installed differently. On a south-facing terrace, both patio covers with fabric (**Lagune** and **Lapure**) and with tiltable blades (**Camargue Line** & **Algarve Line**) are a good solution. A closed fabric or shut blades protect perfectly against solar heat. For a louvered roof it is best to place the blades parallel to the house. This is the best way to control the amount of sunlight entering the house: allowing full, partial or no blocking of sunrays.

For a north-facing terrace it's a good idea to place the blades perpendicular to the wall. This enables the best control of the incidence of light from the east or west, while a maximum incidence of light is realised in the retracted position.

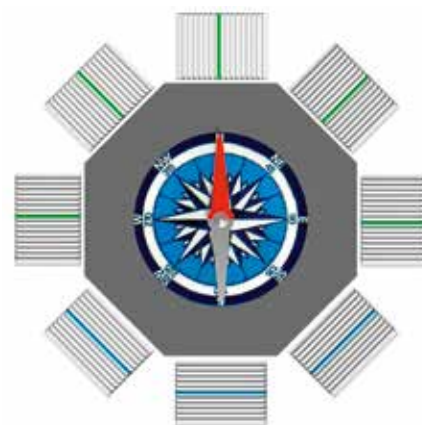

- E-NE-N-NW-W: blades perpendicular to the wall.
- SW-S-SE: blades parallel to the wall.

# RENSON®: YOUR PARTNER IN VENTILATION, SUN PROTECTION AND OUTDOOR CONCEPTS

---

Renson®, with head office in Waregem (Belgium), is a European trendsetter when it comes to ventilation, sun protection and outdoor.

## **Creating healthy spaces**

Based on experience gained since 1909, we develop energy-efficient total solutions to achieve a healthy and comfortable indoor and outdoor climate. Our remarkable head office, built in accordance with the 'Healthy Building Concept', is a perfect example of our corporate mission.

## **No speed limit on innovation**

A multidisciplinary team of more than 90 R&D specialists is continually optimizing our existing products and developing innovative total concepts.

## **WHERE CAN I GO TO FOR RENSON® PRODUCTS AS END CUSTOMER?**

In order to guarantee high-quality expertise and professional placement of the Renson® products, we have built up a network of well-trained Ambassadors.

### **RENSON® Premium Ambassadors**

These are ambassadors who have years of experience in selling and installing Renson® products. They also keep our entire range and guarantee the most professional guidance.

**RENSON® Ambassadors** showcase our products in their showroom and ensure that the purchased product is placed professionally and properly with their own placement team. They also guarantee a professional after-sales service.

Also visit: [www.renson.eu](http://www.renson.eu)





**RENOVATION/ (RE) BUILDING  
PLANS? VISIT OUR SHOWROOM**

EXIT 5 is open  
Monday through Friday: 8u00 - 18u00  
Saturday: 9u00 - 12u00

Make an appointment by phone on  
056 62 96 87 or online via [www.exit5.be](http://www.exit5.be)

Maalbeekstraat 10 - 8790 Waregem - Belgium  
[www.exit5.be](http://www.exit5.be)

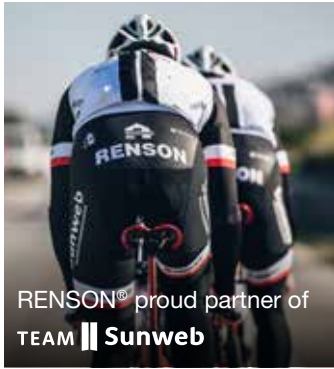

RENSON® proud partner of  
TEAM **Sunweb**



Creating healthy spaces

RENSON® Headquarters  
Maalbeekstraat 10, IZ 2 Vijverdam B-8790 Waregem  
Tel. +32 (0)56 62 71 11  
info@renson.eu  
www.renson.eu

